

# CREWE'D JOTTINGS

## Issue 11

### **"Terms and Conditions of this Newsletter."**

The views expressed on this Newsletter are those of each Author and not necessarily those of the Rolls-Royce Club of Australia.

The information contained in this material is only for information purposes.

The material does not constitute advice and you should not rely on any material in this web site to make (or refrain from making) any decision or take (or refrain from taking) any action. We do not make any warranty or representation as to the accuracy or fitness for purpose of any material in this Newsletter.

In no event do we accept liability of any description, including liability for negligence, for any damages or losses (including, without limitation, loss of business, revenue, profits, or consequential loss) whatsoever resulting from use of or inability to use this Newsletter.

The information contained in this Newsletter may contain technical inaccuracies and typographical errors. The information contains material submitted and created by third parties. We exclude all liability for any illegality arising from or error, omission or inaccuracy in such material" The purpose of these self-help gatherings is to gain a better understanding and a working knowledge of the vehicles in our charge.

It does not nor is it intended to imply that the work carried out on these vehicles will replace the expert knowledge of those that specialise in this field.

Each owner is strongly encouraged to keep his or her motorcar maintained by a qualified professional unless they have a thorough working knowledge of the vehicle themselves.

### **Some Photos (And a drawing of Silver Spur Convertibles).**



## FEBRUARY 4th. 2007 REPORT

We needed a coffee fix to get us into gear for the first Self-help meeting of the year and our original intention was to get stuck into Paul D... 's Silver Shadow and change his thermostat and coolant. Trouble was, Paul didn't check his stats and hadn't enough coolant to do the job. Not to worry; there's always next time.

In the meantime, another Shadow fronted up for a check on the hydraulics. There was a leak from the height control valve and a loss of brake fluid.



**In Need Of Urgent Attention**  
These Brake Hoses Are On The Verge Of Rupturing  
And Their Feel Is Of The Consistency Of Gel.

We initially wanted to replace the brake pads in addition to fixing the height control valve leak, but the brake hoses were also in need of replacement. The front disc calliper on the left was seized and the disc rotors at the front were badly scored.

As our group can only attend to a job that needs to be up and running on the same day, we drew our attention back to the initial task.



**Another View Of The Scoring**



**Sadly, The Disc Rotors Are Scored Beyond Repair**

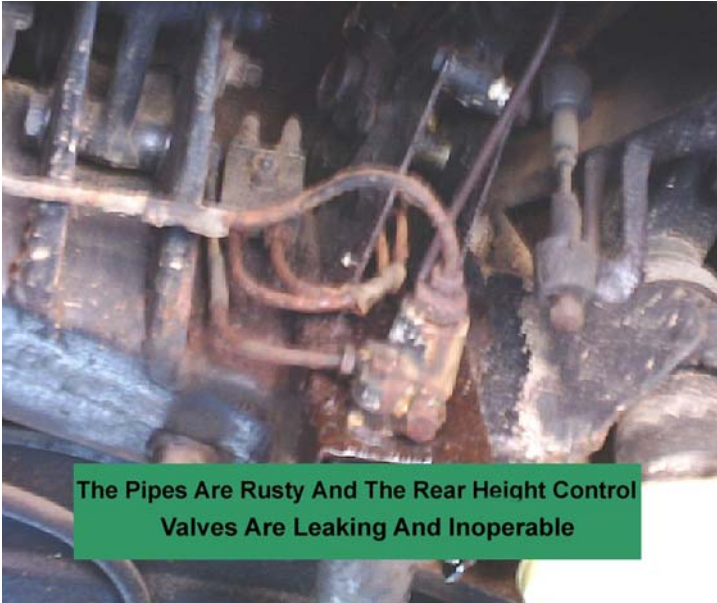

The Pipes Are Rusty And The Rear Height Control Valves Are Leaking And Inoperable

Mark managed to attend to the leak by blanking off the height control valves with ball bearings (At least the driveway will be clean for the present) and the custodian of the vehicle can decide on the next course of action.

It was a relatively slow start to the year work-wise, but there are many projects coming up in the following months and a few nice surprises too.

### Turbo R tip from Clive

Clive Lungmuss is rapidly becoming a regular and welcome contributor to Crewe'd Jottings.

I will reprint his suggestions here verbatim.

Hello Rob,

Hope you had a good Christmas and that 2007 will bring you many miles of happy motoring. Thanks for the articles, magazines , etc. you send along.

I wrote that article about changing gas spheres and today I have just changed the front spheres on a Turbo R for someone. As you perhaps are aware you have to take the front accumulator off (usually with the sphere) to access the rear sphere. My note or hint to you today is putting the first sphere/accumulator back on (after you have put N0.2 sphere on).

By trial and some error I found the following useful.

- 1 Attach the lower rubber pipe to the Accumulator
- 2 Attach the two pipes at the top of the Accumulator
- 3 Now put in the bolts and tighten the bolts that hold the Accumulator to the chassis
- 4 Now tighten clip on rubber hose & the two pipes.

This came about as I had put the Accumulator on and then tried to gather the thread for the two pipes - hopeless. So I undid & removed the holding bolts and then easily attached the two pipes (the rubber hose holds the accumulator). Possibly at manufacture that had been done because I could not get the angle right for the thread to engage.

Hope this helps someone somewhere.

regards,  
Clive

To expand on Clive's letter, I will include his full article below.

Thank you Clive.

## *A Layman's Guide to Changing the Front & Rear Spheres. Silver Spirit & Bentley Turbo R*

Often the question arises 'when do they need changing or how do you know they need changing?'

In my own case I had been aware that my RR Spirit had a different feel about it from my Turbo R but most of the time with me being the only occupant of the car the different 'feel' was not a priority. It was not until a friend sat in the back of the RR and he was being visibly shaken about did the problem become more apparent. In fact he questioned the comfort of the world's best car as his head movement was reminiscent of one of those 'nodding dogs' used as a promotional item by a well known car insurance company. So the time had arrived when those gas spring spheres were making it known that they needed changing.

For an explanation of how the spheres function and how they contribute to that 'perfect' ride you should read Bill Coburn's Tee One Topics N0.24 May 2003

### Rear Gas Spring Suspension Spheres

The first requirement is to de - pressurise the hydraulic system. If you are changing only the rear and not the front spheres this is quickest done by pumping the brake pedal. Do this repeatedly (20 to 30 times is usually sufficient) or until your leg gets tired. Turn on the ignition a few times during the process. Once both facia warning lamps are illuminated, pump 10 more times. If you are replacing the front main accumulator spheres at the same time, you may choose to relieve the system internally by opening the bleed screws on the front accumulator valve bodies instead (No fluid will flow from the system as it is an internal bleed system). Now attach clean plastic tubing to the rear strut bleed nipples that are situated inside the body beneath the rear doors. Open the bleed nipples and collect the drained fluid in a suitable container. You may wish to let the fluid drain into a large pan and don't use the tube. The tube can get in the way of the spanner. Never reuse the fluid as it is easily contaminated.

The next step is to disconnect the battery. This is vital as you will be moving the Master Switch to one side.

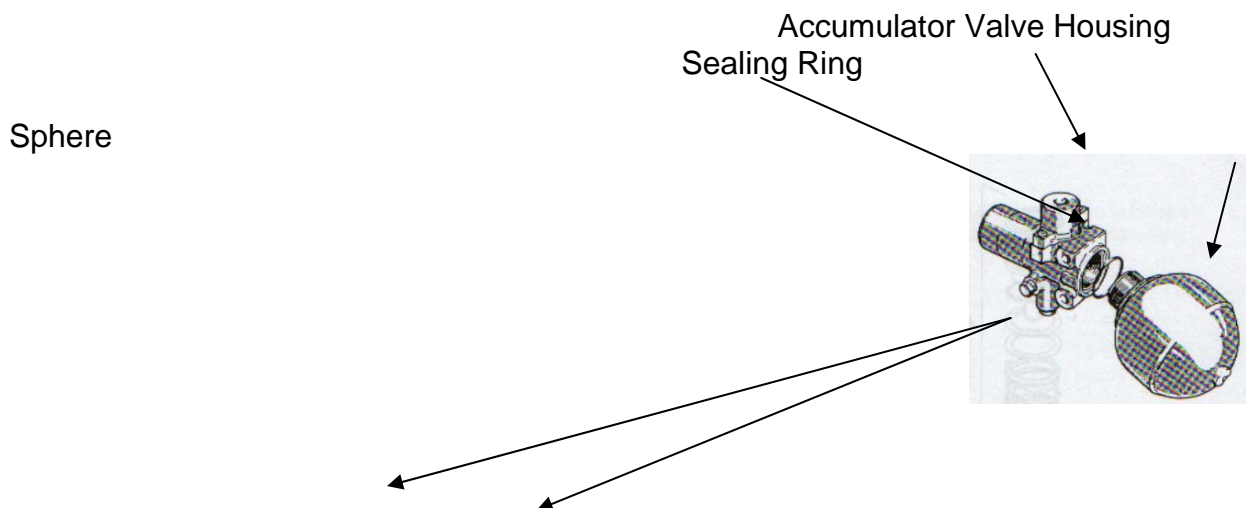

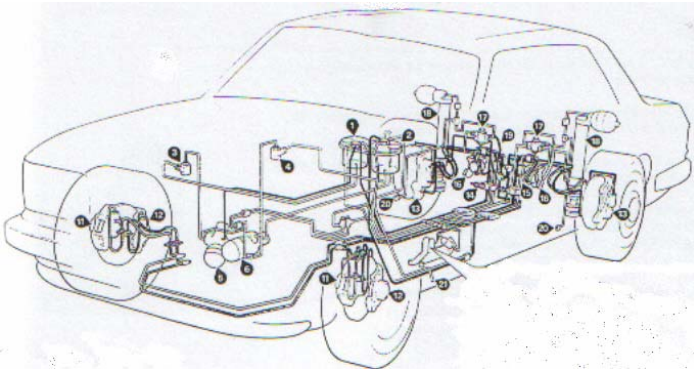

To gain access to the spheres remove the carpets and any other items from the boot. I also removed the side panels above the wheel arches and then finally remove the rear panel by first unscrewing the ferrule from around the battery cut out switch. The panels generally can be released by undoing the several Phillips screws. Put these in a safe place along with the cups they rest they in. With the panel removed it is possible then to see the spheres that are just behind and close to each boot hinge. Now undo the bracket holding the battery cut out switch and push to one side. With the aid of an oil filter removal tool (webbing) you should be able to apply just enough pressure for the spheres to unscrew. Access to the spheres is very limited and I had considerable difficulty putting any tool around the spheres. In desperation I managed to get my hands around each of them in turn and unscrew them (I may well have unknowingly loosened them with my previous attempts). When they first move do have thick cloths or old towels handy to put under the sphere.

I advise this as in my case a considerable amount of hydraulic fluid flowed out and you will not want this draining into any awkward places.

You now need to ease the spheres out with their seals and remove from the car. Take the new spheres with the new seal's, moisten the seal with a drop of clean hydraulic fluid and position in the valve housing. Screw on the sphere (Stop at this point). With a torch and an instrument screwdriver make sure that the sealing ring is perfectly in place before tightening fully) into its housing and hand tighten. Using the oil filter tool 'pinch' each one up to ensure a good fluid free seal. Reposition the cut out switch and connect the battery.

The next task is to bleed the system (weight is only needed on Silver Shadows as SZ cars sit on their gas springs). At this stage you should make sure your hydraulic reservoirs are full and you have sufficient bottles of clean hydraulic fluid (6 bottles). Open both bleed nipples making sure the plastic tube end is resting in some fluid. I have been since advised that the tubes can be dispensed with, just open the bleed nipples a little. Start the engine and let the oil flow until it is free of any bubbles. DO MAKE sure you keep the hydraulic reservoirs full. In my own case I did not bleed them both at the same time but individually.

Close the bleed nipples, check for any leaks around the spheres then refit the panels and carpeting

## *Renewing the Front Spheres (Accumulators) Silver Spirit & Bentley Turbo R*

To find out the condition of the Accumulators/Spheres run the engine for 4 minutes, switch off the engine but leave the ignition on. Press the brake pedal and start to keep count – 60 presses before the facia panel brake warning light comes on is good, 30 presses all right, 10 or less BAD – *change those spheres*.

**SAFETY WARNING** – Depressurise before carrying out any work on the Hydraulic System. The simplest and quickest method I found was to switch on the ignition and pump the brake pedal 50 to 60 times until the resistance at the pedal reduces. The facia brake warning panel or panels should be illuminated. Switch off ignition. If you are replacing the front main accumulator spheres you may choose to relieve the system internally by opening the bleed screws on the front accumulator valve bodies instead (No fluid will flow from the system as it is an internal bleed system).

Sitting in the car the Accumulators/Spheres on the Silver Spirit are to be found on the right hand (A Bank) side of the engine, on the Bentley Turbo they are on the left hand (B Bank) side of the engine, confusing but I hope you are managing to keep up. For the 30,000 Series cars onwards, the accumulator's locations are all standardised and are located on the B - Bank as on all Turbo's. I found it a lot easier to work with the front road wheels removed, so now loosen the nuts before jacking the car up and placing axle stands, wooden blocks in position. To keep the confused condition at 100% please remember that the wheel nuts on the left hand side (passenger side) undo the OPPOSITE way. That is they undo clockwise on the left hand side. Useful to remember this before you apply the torque wrench or extended bar to a wheel nut that seems stuck and ruin the brass nuts! Use a little high-temperature grease when you refit the wheel nuts.

**(Continued next page)**

## **SILVER SPIRIT**

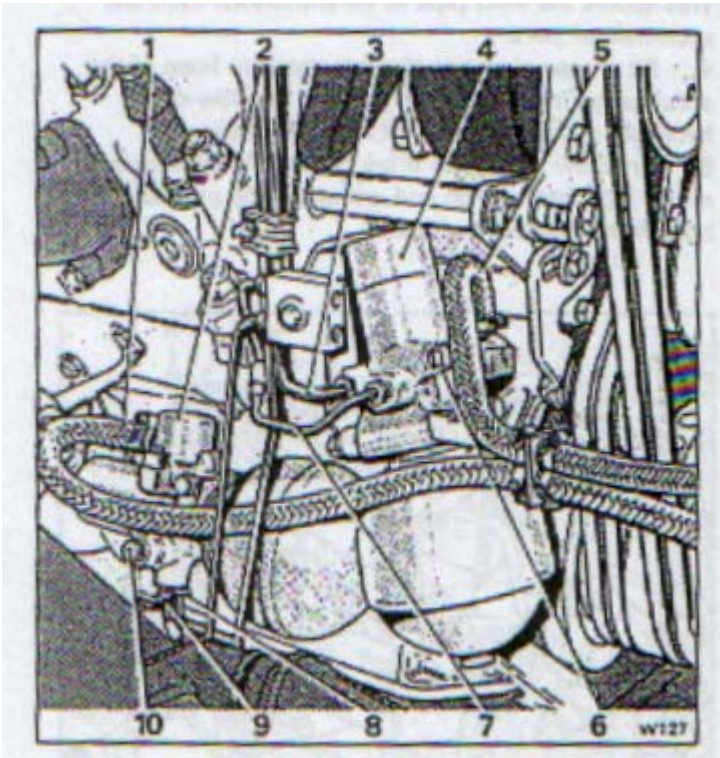

### **Hydraulic Accumulators (R R)**

- 1 Low pressure return to Reservoir
- 2 Accumulator (No. 2 System)
- 3 High pressure inlet from pump
- 4 Accumulator (No. 1 System)
- 5 Low return to reservoir
- 6 Bleed Screw
- 7 High pressure outlet to upper distribution valve and right hand suspension strut.
- 8 High pressure inlet from pump
- 9 High pressure outlet to lower distribution valve and left hand suspension strut.
- 10 Bleed screw

It seemed logical to start with the front Accumulator/Sphere (No 1 System). Here again the book advises the use of a suitable chain wrench located around the circumference of the sphere. (I did see on Ebay a special Citroen Tool for removing said spheres). The long and the short of it I tried everything, even prayer but they would not shift. After a week I consulted over a beer with our local Citroen engineer and his advice – use a hammer and chisel!! I have never told anyone about this as I was in constant dread of being the RREC member known to have taken a hammer & chisel to a Rolls Royce! So secretly I did and cut a small notch into the circumference and tapped, hammered and after a much shorter time than a week it MOVED! Unscrewed it and removed to one side. Used the same tactics and delicate skill on No 2 and soon that was to one side with No 1. Make sure both old sealing rings have been removed from the valve body.

Locate the new sealing ring lubricated with clean hydraulic mineral oil into the valve body. Fit the new Accumulator/Sphere to the valve body and torque tighten to 18 –33 lbf ft. Here again I found I was unable to do this so they were tightened up by hand then pinched up using the chain wrench. Top up the reservoirs and then start the engine and check for leaks. Switch off the engine and depressurise the system. Now open bleed screws A & B. Start the engine again and ensure the facia brake panel lights are illuminated, run the engine for one minute at 1500 rpm. Switch off the engine, close the bleed nipples A& B, replace the road wheel, remove blocks, axle stands etc and lower the car gently to the ground. Tighten the wheel nuts and that's another of those jobs completed.

## **Bentley Turbo R**

As previously mentioned the Accumulators are on the left hand (B Bank) side of the engine as seen sitting in the car. This will require the removal of the near side wheel. Remember the nuts undo the opposite way.

With the car jacked up and axle stands safely in place remove the wheel out of the way.

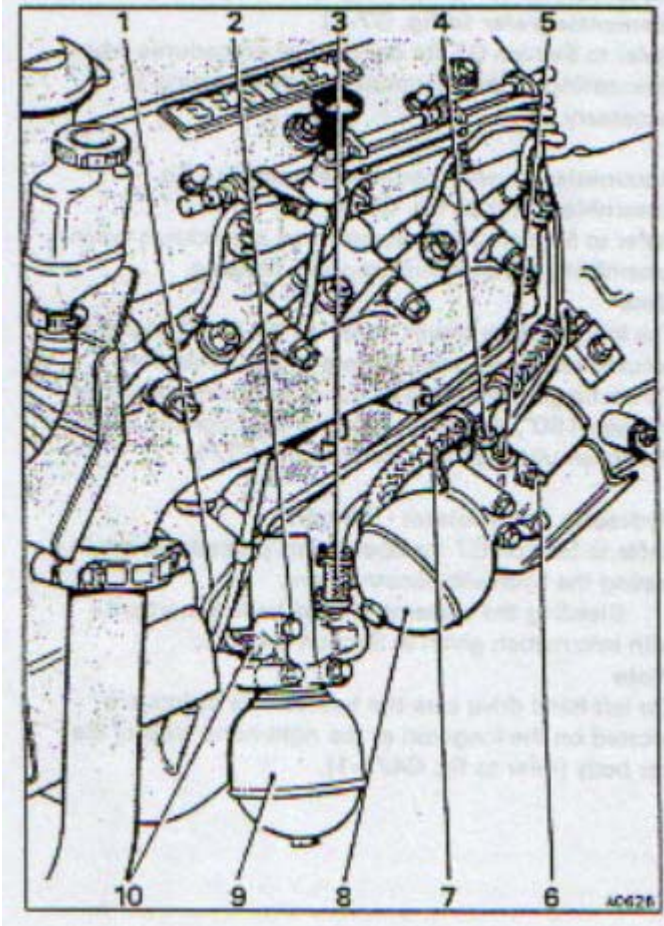

Hydraulic Accumulators (Turbo R)

- 1 High pressure inlet from pump
- 2 Bleed screw
- 3 Low pressure return to reservoir
- 4 High pressure inlet from pump
- 5 High pressure outlet to low distribution valve and pressure switch
- 6 Bleed screw
- 7 Low pressure return to reservoir
- 8 Accumulator (No. 2 system)
- 9 Accumulator (No. 1 system)
- 10 High pressure outlet to upper distribution valve, left hand and right hand suspension struts.

**SAFETY WARNING** – Depressurise before carrying out any work on the Hydraulic System. The simplest and quickest method I found was to switch the ignition and pump the brake pedal 50 to 60 times until the resistance at the pedal reduces. The facia brake warning panel or panels should be illuminated. Switch off ignition. If you are replacing the front main accumulator spheres you may choose to relieve the system internally by opening the bleed screws on the front accumulator valve bodies instead (No fluid will flow from the system as it is an internal bleed system).

If I can remember correctly I had to remove shield in front of first accumulator (No.1) if you don't have one it doesn't matter. To enable you remove accumulator No. 2 the valve housing for No.1 has to be removed so that the No. 2 sphere can be fully unscrewed. So on the No.1 valve housing, disconnect the high pressure pipe and return pipe. I have since been advised it is better to remove the sphere off the car. Undo the two retaining bolts and lower the valve housing away from the car. Now you have access to accumulator on the NO.2 system so you can unscrew the sphere using a chain wrench or oil filter removal tool. Make sure the old sealing ring has been removed, moisten the new sealing ring with clean hydraulic fluid and put in position. Now the new accumulator can be screwed into position, a final check to make sure the sealing ring is in the correct place and then tighten up.



Now you can turn your attention to No. 1 system. Undo the sphere, again make sure the old sealing ring is out. Moisten the new sealing ring with clean hydraulic fluid and place in position. Screw in the new accumulator, checking the sealing ring is correctly positioned and tighten up. Refit the valve housing, pipes etc. Replace the guard if you have one.

Top up the reservoirs and then start the engine and check for leaks. Switch off the engine and depressurise the system. Now open bleed screws A & B. Start the engine again and ensure the facia brake panel lights are illuminated, run the engine for one minute at 1500 rpm. Switch off the engine, close the bleed nipples A & B, replace the road wheel, remove blocks, axle stands etc and lower the car gently to the ground. Tighten the wheel nuts and that is another job completed.

### *Special Torque Tightening Figures*

Bleed Screws	6 – 7 lbf ft.
Pipe Nuts – High Pressure Inlet from pump No.1 & No. 2 systems	7 – 8 lbf ft.
Pipe Nuts – High Pressure outlets to upper distribution valve, right hand and left hand suspension strut	6 – 7lbf ft.
Sphere to Accumulator Body	18 – 33 lbf ft.

These jobs always take me a bit longer as while I have access I like to carry out some preventative maintenance. Check & clean brake pipes, inspect brake pads, oil and grease all bolts etc. You never know what the next job is going to be. I have also removed, inspected and cleaned the protective coverings under the wings.

The question often comes where to buy gas spring spheres/ accumulator spheres? My inclination is to purchase through Dealer Spares as using any others may be introducing a variable into a problem you are trying to solve. Advertised re-charged spheres, low cost spheres that also fit earth moving machinery do not appeal to me and I would have that uneasy feeling I could be doing the same job again to soon.

Happy motoring

Clive Lungmuss  
With thanks to Richard Treacy & Bill Coburn  
28/02/06

**Thank you Clive, your insight is legendary and we look forward to more of your articles in the future.**

Steve \_\_\_\_\_ decided that he was going to officially take on the duties as Head Chef with our new BBQ, so kindly donated by George Sokol (I'm hoping he'll pay us a visit so he can partake of our culinary pleasures and get to sample a couple of our motorcars).

Steve was very impressed and we had to virtually prize him away from it afterwards.

Here are some photos.



**Steve Has Done Everything Short Of Applying For Adoption Papers For Our New BBQ**

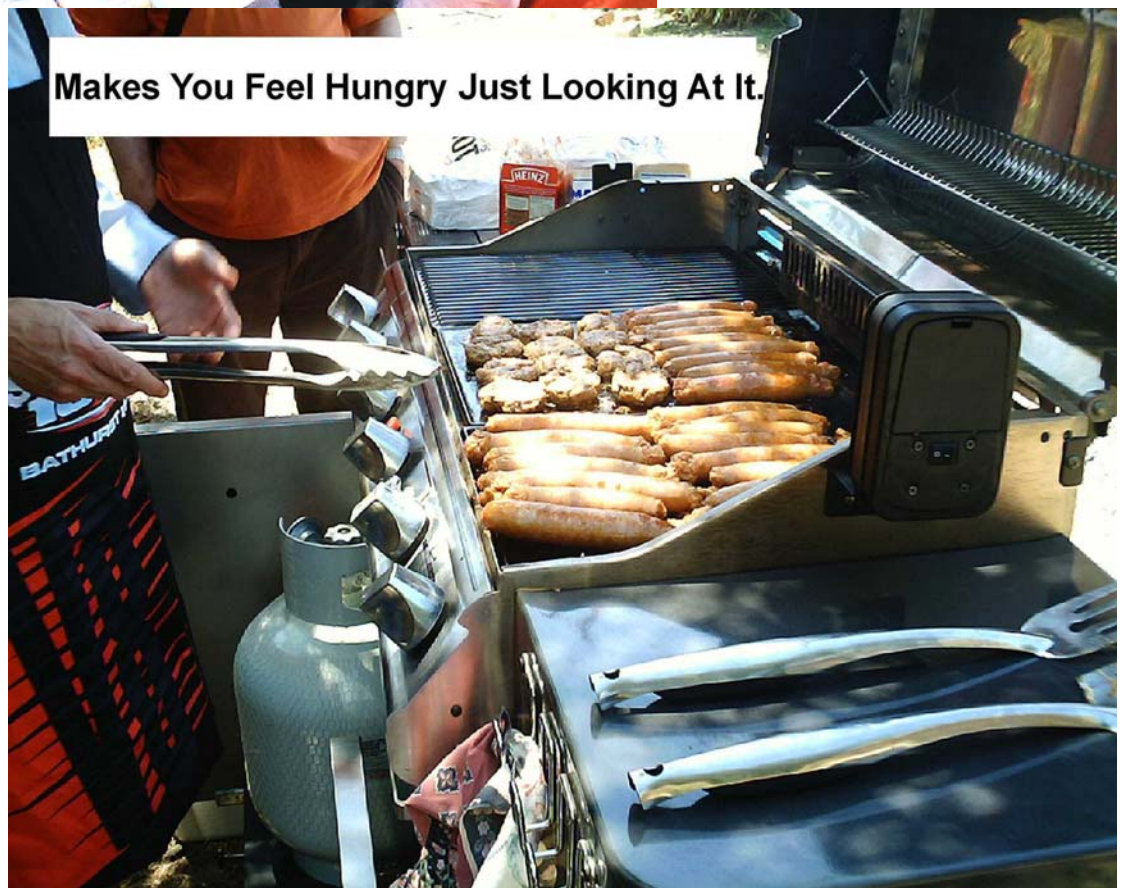

**Makes You Feel Hungry Just Looking At It.**

We seem to be enjoying a few 'Freebies' lately.

Member, Simon Roberts donated a grease gun to the effort with the correct slide-on (Tecalemit), fitting for our flat-topped grease nipples.

This can be used by any member at any time and we thank Simon for his very useful addition to our toolkit.

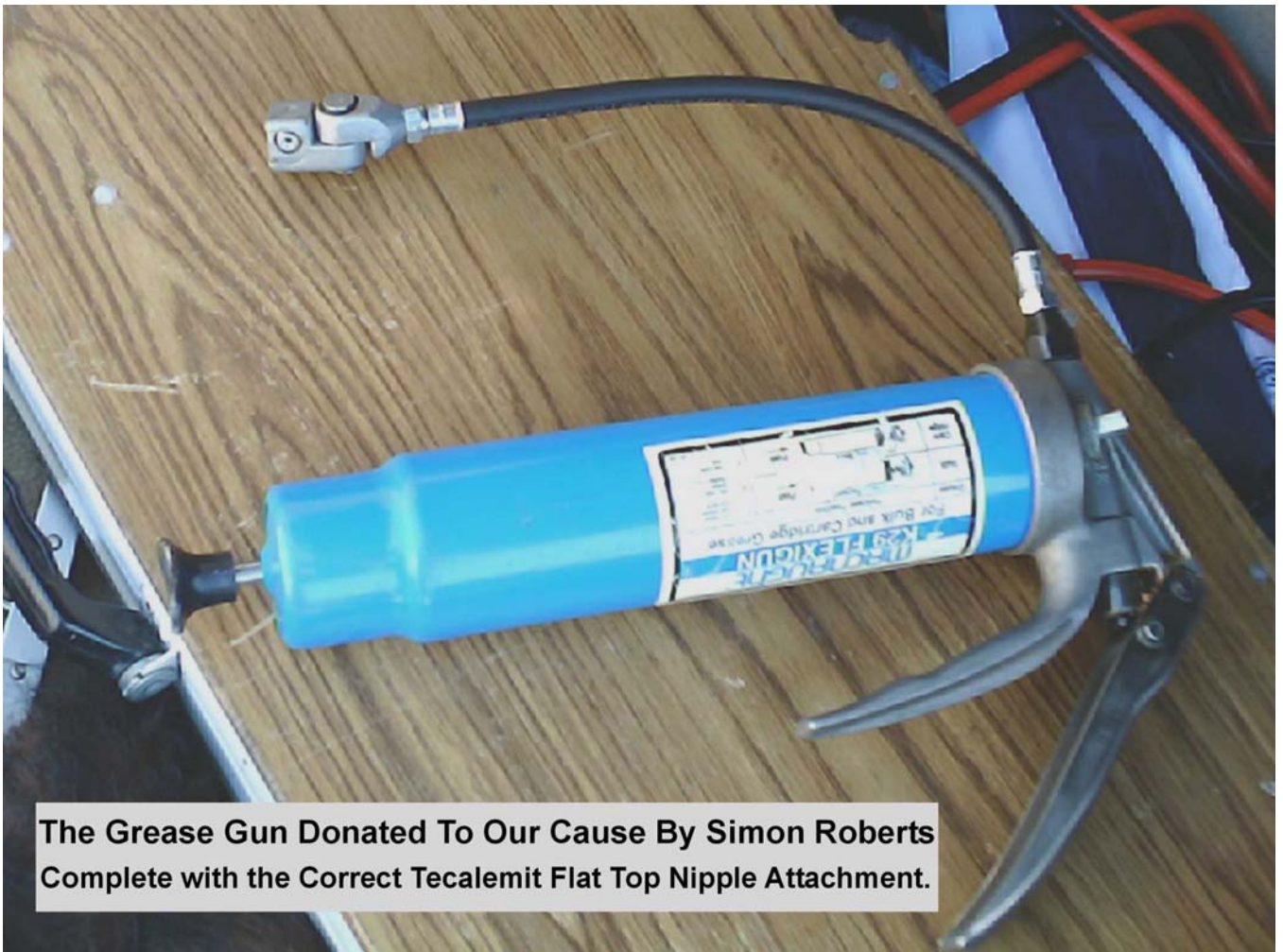

'Til next time folks,

Happy and safe motoring.

*Robert Wort*

\*\*\*\*\*  
\*\*\*\*\* \* \*\*\*\*\*  
\*\*\*\*\*